



ATTESTATION of conformity with European Directives

Product: Bamboo Series USB Flash Drive /
Additional Product Name: Lizzard USB Wristband
Reference **BS / Additional Model Number:** WB
Issued to **FLASHBAY ELECTRONICS (SHENZHEN) CO., LTD**
Address **3-5/F, Bldg B, Xifengcheng Industrial Park, No.2 Fuyuan Rd,
2nd High-tech Area, Heping, Fuyong, Baoan, Shenzhen 518103,
Guangdong Province, P.R.China**
Manufacturer **FLASHBAY ELECTRONICS (SHENZHEN) CO., LTD**
Technical characteristics **230Va.c. 50Hz**

The submitted sample of the above equipment has been tested for **CE** marking according to following European Directive and following standards:

- Electromagnetic directive 2004/108/EC

<i>Standards</i>	<i>Report number</i>	<i>Report date</i>
EN 55022: 2006 EN 55024: 1998 +A1: 2001 +A2: 2003 EN 61000-3-2: 2006 EN 61000-3-3: 2008	(5209)180-0049	2009 July 6

The referred test report(s) show that the product complies with standard(s) recognized as giving presumption of compliance with the essential requirements in the specified European Directive

This verification does not imply assessment of the production of the product
The **CE** marking may be affixed if all relevant and effective European Directives with **CE** are applicable

HK, 2009 July 6



**Manager,
Electrical Department**

Name: Steven Tsang

This document shall not be reproduced, except in full, without the written approval of BV LCIE HK. Information given in this document, are related to the tested specimen of the described electrical sample.



TEST REPORT No.: (5209)180-0049

Testing Program

The tests have been carried out according to the requirements of the following standards :

Test Standards	
EN 55022: 2006	Information technology equipment - Radio disturbance characteristics - Limits and methods of measurement
EN 55024: 1998 +A1: 2001 +A2: 2003	Information technology equipment - Immunity characteristics - Limits and methods of measurement
EN61000-3-2: 2006	Electromagnetic compatibility (EMC) - Part 3-2: Limits - Limits for harmonic current emissions (equipment input current \leq 16A per phase)
EN61000-3-3: 2008	Electromagnetic compatibility (EMC) - Part 3-3: Limits - Limit - Limitation of voltage changes, voltage fluctuations and flicker in public low-voltage supply systems, for equipment with rated current \leq 16A per phase and not subject to conditional connection (equipment input current \leq 16A per phase)

Equipment Under Test:

The equipment under test is Bamboo Series USB Flash Drive. Model: BS.

Additional Product Name:

Lizzard USB Wristband

Additional Model Number:

WB

Additional Model Information:

Declare the Circuit, PCB layout, Electrical parts and Outlook of the products are identical to the basic model. Except the shape and color of the shells.

This report is intended for your exclusive use. Any copying or replication of this report to or for any other person or entity, or use of our name or trademark, is permitted only with our prior written permission. Our report is limited to the test samples identified herein. The results set forth in this report are not necessarily indicative or representative of the statistical quality or characteristics of the lot from which a test sample was taken or any similar or identical product unless specifically and expressly noted. Our report includes all of the tests requested by you and the results thereof. You shall have thirty days from receipt of this report to request additional testing of the samples or to notify us of any errors or omissions relating to our report, provided, however, such notice shall be in writing and shall specifically address the issue you wish to raise. A failure to raise such issue within the prescribed time shall constitute your unqualified acceptance of the completeness of this report, the tests conducted and the correctness of the report contents.

BUREAU VERITAS HONG KONG LIMITED
- Kowloon Bay Office

1/F Pacific Trade Centre,
2 Kai Hing Road, Kowloon Bay,
Kowloon, HONG KONG

Tel: +852 2331 0888
Fax: +852 2331 0889
www.cps.bureauveritas.com



TEST REPORT No.: (5209)180-0049

Test Site(s) & Test Instruments List

Test Site(s)

BUREAU VERITAS HONG KONG LIMITED, EMC CENTRE

No. 2106-2107, 21/F., Westin Centre, 26 Hung To Road, Kwun Tong, Kowloon, Hong Kong

Test Instrument List

Radiated Emission

EQUIPMENT	MANUFACTURER	MODEL NO.	SERIAL NO.
EMI TEST RECEIVER	R&S	ESCI	100379
BILOG ANTENNA	SCHAFFNER	CBL6112D	25229
OPEN AREA TEST SITE	BVCPS	N/A	N/A
ANECHOIC CHAMBER	ALBATROSS	M-CDC	80374004499B
BICONICAL ANTENNA	ROHDE & SCHWARZ	HK116	100179
LOG-PERIODIC DIPOLE ARRAY ANTENNA	ROHDE & SCHWARZ	HL223	832369/001

Conducted Emission

EQUIPMENT	MANUFACTURER	MODEL NO.	SERIAL NO.
EMI TEST RECEIVER	ROHDE & SCHWARZ	ESCS 30	830986/030
LISN	ROHDE & SCHWARZ	ENV216	100024
PULSE LIMITER	ROHDE & SCHWARZ	ESH3 Z2	100088

Harmonics, Flicker and Harmonics Immunity

EQUIPMENT	MANUFACTURER	MODEL NO.	SERIAL NO.
PROFLINE 2103-240 SINGLE PHASE 3KV SYSTEM	SCHAFFNER	PROFLINE: 2103-240-413 NSG: 1007-3-240-413 CCN: 1000-1	58396 AND 72614

Electro-Static Discharge

EQUIPMENT	MANUFACTURER	MODEL NO.	SERIAL NO.
ESD SIMULATOR	KIKUSUI	KES 4021	ME004852

EFT, Surge and Voltage Dip

EQUIPMENT	MANUFACTURER	MODEL NO.	SERIAL NO.
MULTIFUNCTION GENERATOR	SCHAFFNER	MODULA 6150	34586

This report is intended for your exclusive use. Any copying or replication of this report to or for any other person or entity, or use of our name or trademark, is permitted only with our prior written permission. Our report is limited to the test samples identified herein. The results set forth in this report are not necessarily indicative or representative of the statistical quality or characteristics of the lot from which a test sample was taken or any similar or identical product unless specifically and expressly noted. Our report includes all of the tests requested by you and the results thereof. You shall have thirty days from receipt of this report to request additional testing of the samples or to notify us of any errors or omissions relating to our report, provided, however, such notice shall be in writing and shall specifically address the issue you wish to raise. A failure to raise such issue within the prescribed time shall constitute your unqualified acceptance of the completeness of this report, the tests conducted and the correctness of the report contents.

BUREAU VERITAS HONG KONG LIMITED
- Kowloon Bay Office

1/F Pacific Trade Centre,
2 Kai Hing Road, Kowloon Bay,
Kowloon, HONG KONG

Tel: +852 2331 0888
Fax: +852 2331 0889
www.cps.bureauveritas.com



TEST REPORT No.: (5209)180-0049

Radiated Immunity

EQUIPMENT	MANUFACTURER	MODEL NO.	SERIAL NO.
SIGNAL GENERATOR	R&S	SMB100A	100981
RF AMPLIFIER	SCHAFFNER	CBA 9433	T43544
ANTENNA X-WING BILOG TYPE	SCHAFFNER	CBL 6143	5123
POWER METER	R&S	NRVD	102067
Power Amplifier	MIILMEGA	AS0104-55_55	1029808

Conducted Immunity

EQUIPMENT	MANUFACTURER	MODEL NO.	SERIAL NO.
SIGNAL GENERATOR	IFR	2023 A	202304/386
RF POWER AMPLIFIER	HAEFELY	PAMP 250	145611
M2 / M3 COUPLER	LUTHI	L-801 M2 / M3	2016

Remarks: -

N/A : Not Applicable or Not Available

The measurement instrumentation uncertainty would be taking into consideration on each of the test result

This report is intended for your exclusive use. Any copying or replication of this report to or for any other person or entity, or use of our name or trademark, is permitted only with our prior written permission. Our report is limited to the test samples identified herein. The results set forth in this report are not necessarily indicative or representative of the statistical quality or characteristics of the lot from which a test sample was taken or any similar or identical product unless specifically and expressly noted. Our report includes all of the tests requested by you and the results thereof. You shall have thirty days from receipt of this report to request additional testing of the samples or to notify us of any errors or omissions relating to our report, provided, however, such notice shall be in writing and shall specifically address the issue you wish to raise. A failure to raise such issue within the prescribed time shall constitute your unqualified acceptance of the completeness of this report, the tests conducted and the correctness of the report contents.

BUREAU VERITAS HONG KONG LIMITED
- Kowloon Bay Office

1/F Pacific Trade Centre,
2 Kai Hing Road, Kowloon Bay,
Kowloon, HONG KONG

Tel: +852 2331 0888
Fax: +852 2331 0889
www.cps.bureauveritas.com

TEST REPORT No.: (5209)180-0049

Test Results

Emission

Conducted Emissions (150kHz to 30MHz)

Test Requirement: EN 55022
Test Method: CISPR 22
Test Limits: Class B

Test Date(s): 2009-06-29

Mode of Operation: Program running mode (Connected to PC)

Test Method:

Initial measurements were performed in peak and average detection modes on the live line, any emissions recorded within 30dB of the relevant limit lines were re-measured using quasi-peak and average detection on the live and neutral lines with the worst case recorded in the table of results.

The test was performed in accordance with CISPR 22.

Test Setup:

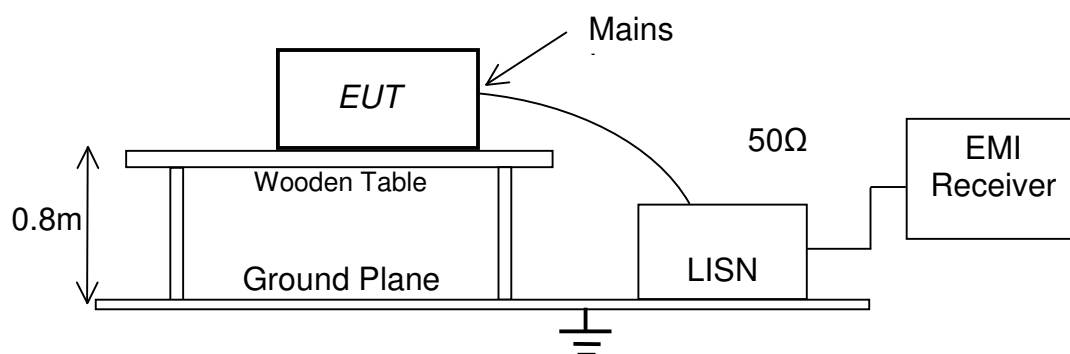

This report is intended for your exclusive use. Any copying or replication of this report to or for any other person or entity, or use of our name or trademark, is permitted only with our prior written permission. Our report is limited to the test samples identified herein. The results set forth in this report are not necessarily indicative or representative of the statistical quality or characteristics of the lot from which a test sample was taken or any similar or identical product unless specifically and expressly noted. Our report includes all of the tests requested by you and the results thereof. You shall have thirty days from receipt of this report to request additional testing of the samples or to notify us of any errors or omissions relating to our report, provided, however, such notice shall be in writing and shall specifically address the issue you wish to raise. A failure to raise such issue within the prescribed time shall constitute your unqualified acceptance of the completeness of this report, the tests conducted and the correctness of the report contents.

BUREAU VERITAS HONG KONG LIMITED
- Kowloon Bay Office

1/F Pacific Trade Centre,
2 Kai Hing Road, Kowloon Bay,
Kowloon, HONG KONG

Tel: +852 2331 0888
Fax: +852 2331 0889
www.cps.bureauveritas.com

TEST REPORT No.: (5209)180-0049

Measurement Data

Test Result of (Program running mode, connected to PC): PASS

Results and limit lines for Conducted Emission:

Limits for Conducted Emission Test, please refer to limit lines (Quasi-Peak and Average) in the following diagram.

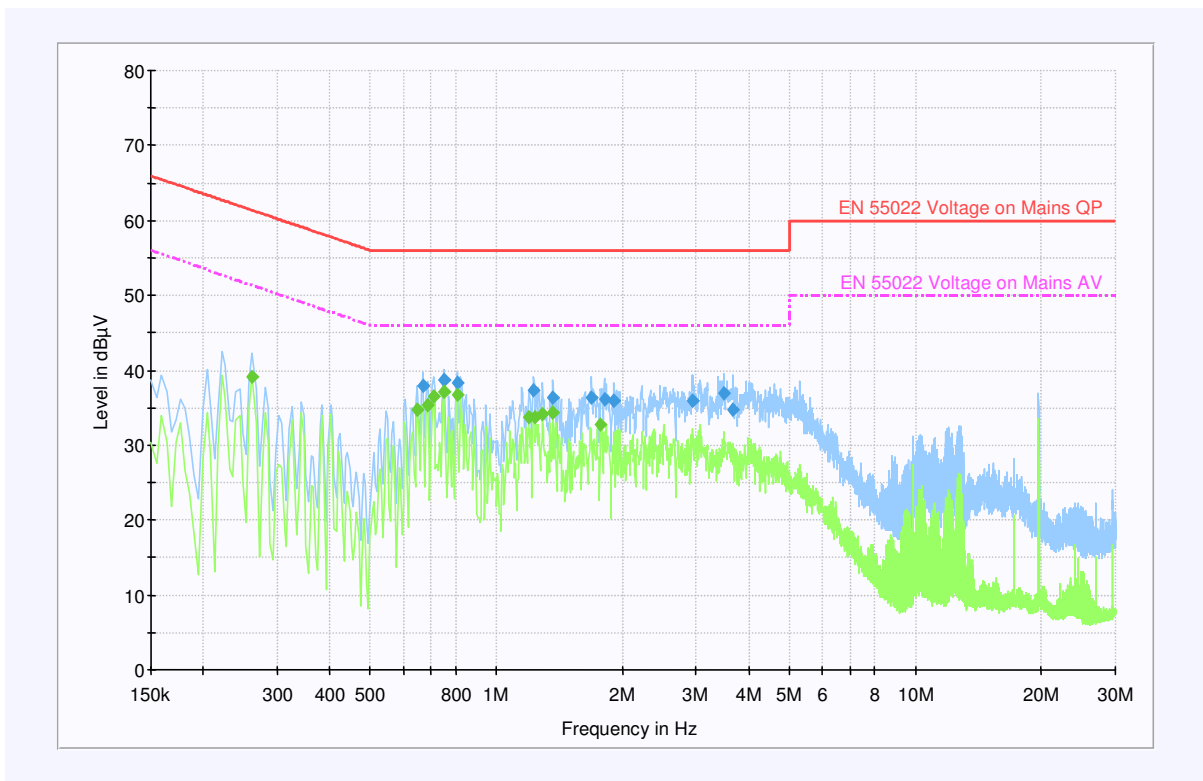

This report is intended for your exclusive use. Any copying or replication of this report to or for any other person or entity, or use of our name or trademark, is permitted only with our prior written permission. Our report is limited to the test samples identified herein. The results set forth in this report are not necessarily indicative or representative of the statistical quality or characteristics of the lot from which a test sample was taken or any similar or identical product unless specifically and expressly noted. Our report includes all of the tests requested by you and the results thereof. You shall have thirty days from receipt of this report to request additional testing of the samples or to notify us of any errors or omissions relating to our report, provided, however, such notice shall be in writing and shall specifically address the issue you wish to raise. A failure to raise such issue within the prescribed time shall constitute your unqualified acceptance of the completeness of this report, the tests conducted and the correctness of the report contents.

BUREAU VERITAS HONG KONG LIMITED
- Kowloon Bay Office

1/F Pacific Trade Centre,
2 Kai Hing Road, Kowloon Bay,
Kowloon, HONG KONG

Tel: +852 2331 0888
Fax: +852 2331 0889
www.cps.bureauveritas.com

TEST REPORT No.: (5209)180-0049

Radiated Emissions (30MHz to 1GHz)

Test Requirement: EN 55022
Test Method: CISPR 22
Test Limits: Class B

Test Date(s): 2009-06-30

Mode of Operation: Program running mode (Connected to PC)

Test Method:

Radiated emissions measurements are investigated and taken pursuant to the procedures of CISPR 22.

The equipment under test (EUT) was placed on a non-conductive turntable with dimensions of 1.5m x 1m and 0.8m high above the ground. 3m from the EUT, a broadband antenna mounting on the mast received the signal strength. The turntable was rotated to maximize the emission level. The antenna was then moving along the mast from 1m up to 4m until no more higher value was found. Both horizontal and vertical polarization of the antenna were placed and investigated.

Test Setup: Open Area Test Site

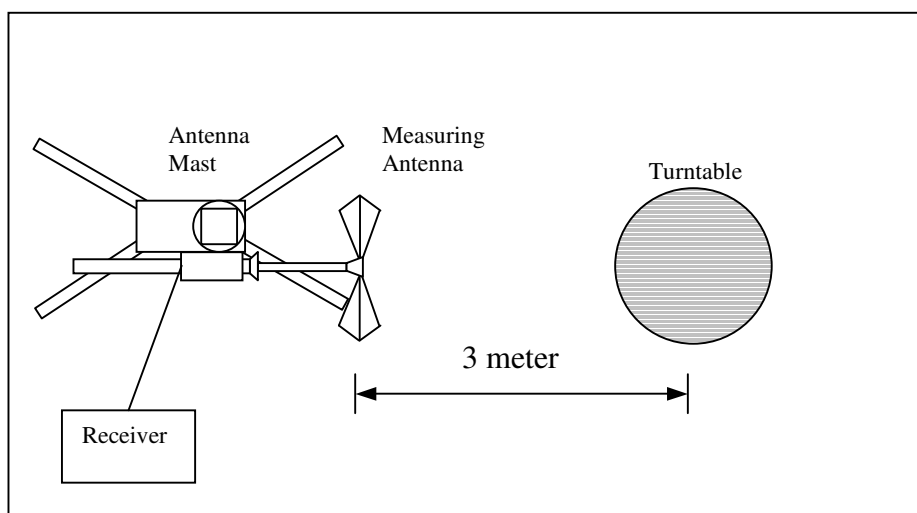

This report is intended for your exclusive use. Any copying or replication of this report to or for any other person or entity, or use of our name or trademark, is permitted only with our prior written permission. Our report is limited to the test samples identified herein. The results set forth in this report are not necessarily indicative or representative of the statistical quality or characteristics of the lot from which a test sample was taken or any similar or identical product unless specifically and expressly noted. Our report includes all of the tests requested by you and the results thereof. You shall have thirty days from receipt of this report to request additional testing of the samples or to notify us of any errors or omissions relating to our report, provided, however, such notice shall be in writing and shall specifically address the issue you wish to raise. A failure to raise such issue within the prescribed time shall constitute your unqualified acceptance of the completeness of this report, the tests conducted and the correctness of the report contents.

BUREAU VERITAS HONG KONG LIMITED
- Kowloon Bay Office

1/F Pacific Trade Centre,
2 Kai Hing Road, Kowloon Bay,
Kowloon, HONG KONG

Tel: +852 2331 0888
Fax: +852 2331 0889
www.cps.bureauveritas.com



TEST REPORT No.: (5209)180-0049

Measurement Data

Test Result of (Program running mode, connected to PC): PASS

Detection mode: Quasi-Peak

Frequency (MHz)	Polarity (H/V)	Field Strength at 3m (dB μ V/m)	Limit at 3m (dB μ V/m)	Margin (dB)
192.04	H	27.4	40.0	-12.6
960.06	V	39.9	47.0	-7.1
192.00	V	26.1	40.0	-13.9
216.60	V	25.1	40.0	-14.9
234.48	V	22.1	47.0	-24.9

Note: Field Strength includes Antenna Factor and Cable Loss.

This report is intended for your exclusive use. Any copying or replication of this report to or for any other person or entity, or use of our name or trademark, is permitted only with our prior written permission. Our report is limited to the test samples identified herein. The results set forth in this report are not necessarily indicative or representative of the statistical quality or characteristics of the lot from which a test sample was taken or any similar or identical product unless specifically and expressly noted. Our report includes all of the tests requested by you and the results thereof. You shall have thirty days from receipt of this report to request additional testing of the samples or to notify us of any errors or omissions relating to our report, provided, however, such notice shall be in writing and shall specifically address the issue you wish to raise. A failure to raise such issue within the prescribed time shall constitute your unqualified acceptance of the completeness of this report, the tests conducted and the correctness of the report contents.

BUREAU VERITAS HONG KONG LIMITED
- Kowloon Bay Office

1/F Pacific Trade Centre,
2 Kai Hing Road, Kowloon Bay,
Kowloon, HONG KONG

Tel: +852 2331 0888
Fax: +852 2331 0889
www.cps.bureauveritas.com



TEST REPORT No.: (5209)180-0049

Harmonics Emissions on AC Supply

Test Requirement: EN 61000-3-2
Test Method: EN 61000-3-2
Classification / Limits: Class A

Test Date(s): 2009-06-30

Mode of Operation: Program running mode (Connected to PC)

Test Method:

The test was performed in accordance with EN 61000-3-2.

This report is intended for your exclusive use. Any copying or replication of this report to or for any other person or entity, or use of our name or trademark, is permitted only with our prior written permission. Our report is limited to the test samples identified herein. The results set forth in this report are not necessarily indicative or representative of the statistical quality or characteristics of the lot from which a test sample was taken or any similar or identical product unless specifically and expressly noted. Our report includes all of the tests requested by you and the results thereof. You shall have thirty days from receipt of this report to request additional testing of the samples or to notify us of any errors or omissions relating to our report, provided, however, such notice shall be in writing and shall specifically address the issue you wish to raise. A failure to raise such issue within the prescribed time shall constitute your unqualified acceptance of the completeness of this report, the tests conducted and the correctness of the report contents.

BUREAU VERITAS HONG KONG LIMITED
- Kowloon Bay Office

1/F Pacific Trade Centre,
2 Kai Hing Road, Kowloon Bay,
Kowloon, HONG KONG

Tel: +852 2331 0888
Fax: +852 2331 0889
www.cps.bureauveritas.com

TEST REPORT No.: (5209)180-0049

Measurement Data

Test Result of (Program running mode, connected to PC): PASS

Results and limit line for Harmonics Emissions:

For limits for Harmonics Emission Test, please refer to limit lines (saw-tooth lines) in the following diagram.

Current & voltage waveforms

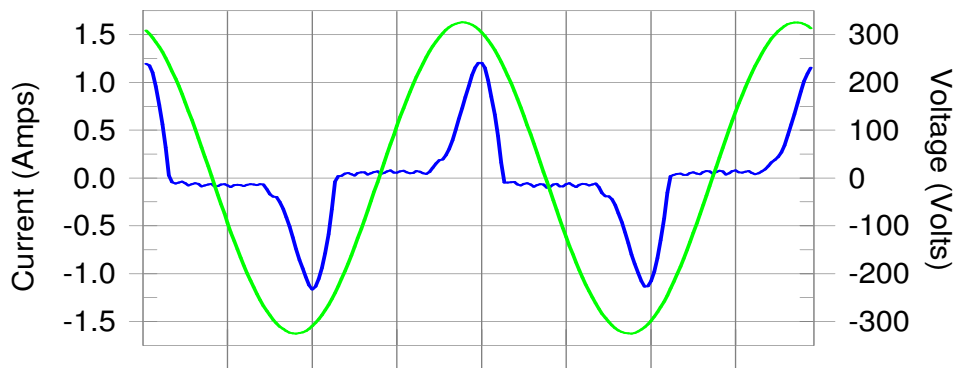

Harmonics and Class A limit line

European Limits

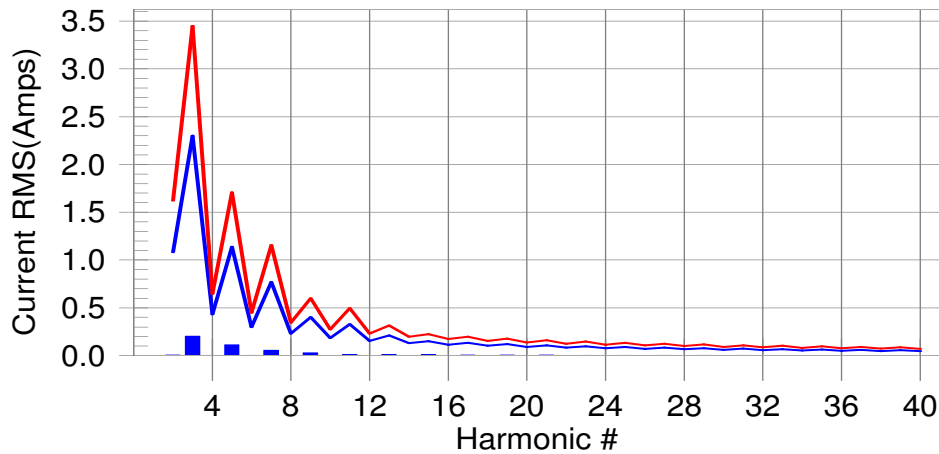

This report is intended for your exclusive use. Any copying or replication of this report to or for any other person or entity, or use of our name or trademark, is permitted only with our prior written permission. Our report is limited to the test samples identified herein. The results set forth in this report are not necessarily indicative or representative of the statistical quality or characteristics of the lot from which a test sample was taken or any similar or identical product unless specifically and expressly noted. Our report includes all of the tests requested by you and the results thereof. You shall have thirty days from receipt of this report to request additional testing of the samples or to notify us of any errors or omissions relating to our report, provided, however, such notice shall be in writing and shall specifically address the issue you wish to raise. A failure to raise such issue within the prescribed time shall constitute your unqualified acceptance of the completeness of this report, the tests conducted and the correctness of the report contents.

BUREAU VERITAS HONG KONG LIMITED
- Kowloon Bay Office

1/F Pacific Trade Centre,
2 Kai Hing Road, Kowloon Bay,
Kowloon, HONG KONG

Tel: +852 2331 0888
Fax: +852 2331 0889
www.cps.bureauveritas.com



TEST REPORT No.: (5209)180-0049

Emission for Fluctuations & Flicker

Test Requirement: EN 61000-3-3

Test Method: EN 61000-3-3

Test Date(s): 2009-06-30

Mode of Operation: Program running mode (Connected to PC)

Test Method:

The test was performed in accordance with EN 61000-3-3.

Limits for Flicker:

Please refer to the result table for details.

Test Result of (Program running mode, connected to PC): PASS

Please refer to the following table for individual results.

Maximum Occurring Levels:

Pst:	0.064	Limit =	1.0	(The Highest Short Term Flicker Value)
Plt:	0.028	Limit =	0.65	(The Highest Long Term Flicker Value)
dc(%):	0.00	Limit =	3.3%	(The Highest Relative Steady State Voltage Change (1sec))
dmax(%):	0.00	Limit =	4%	(*The Highest Maximum Relative Voltage Change)
Tdt(mS):	0.0	Limit =	500ms	(The Max Time (mS) that dt exceeds 3.3%)
Ut(V):	230.01 Va.c.			(EUT Test RMS Voltage)

Remarks:

* - Some products may have more relax limits (refer to Clause 5 of EN 61000-3-3)

This report is intended for your exclusive use. Any copying or replication of this report to or for any other person or entity, or use of our name or trademark, is permitted only with our prior written permission. Our report is limited to the test samples identified herein. The results set forth in this report are not necessarily indicative or representative of the statistical quality or characteristics of the lot from which a test sample was taken or any similar or identical product unless specifically and expressly noted. Our report includes all of the tests requested by you and the results thereof. You shall have thirty days from receipt of this report to request additional testing of the samples or to notify us of any errors or omissions relating to our report, provided, however, such notice shall be in writing and shall specifically address the issue you wish to raise. A failure to raise such issue within the prescribed time shall constitute your unqualified acceptance of the completeness of this report, the tests conducted and the correctness of the report contents.

BUREAU VERITAS HONG KONG LIMITED
- Kowloon Bay Office

1/F Pacific Trade Centre,
2 Kai Hing Road, Kowloon Bay,
Kowloon, HONG KONG

Tel: +852 2331 0888
Fax: +852 2331 0889
www.cps.bureauveritas.com



TEST REPORT No.: (5209)180-0049

Immunity

Susceptibility Performance Criteria

A	Normal performance within the specification limits
B	Temporary degradation or loss of function or performance which is self-recoverable
C	Temporary degradation or loss of function or performance which requires operator intervention or system reset
D	Degradation or loss of function which is not recoverable due to damage of equipment (components) or software, or loss of data

This report is intended for your exclusive use. Any copying or replication of this report to or for any other person or entity, or use of our name or trademark, is permitted only with our prior written permission. Our report is limited to the test samples identified herein. The results set forth in this report are not necessarily indicative or representative of the statistical quality or characteristics of the lot from which a test sample was taken or any similar or identical product unless specifically and expressly noted. Our report includes all of the tests requested by you and the results thereof. You shall have thirty days from receipt of this report to request additional testing of the samples or to notify us of any errors or omissions relating to our report, provided, however, such notice shall be in writing and shall specifically address the issue you wish to raise. A failure to raise such issue within the prescribed time shall constitute your unqualified acceptance of the completeness of this report, the tests conducted and the correctness of the report contents.

BUREAU VERITAS HONG KONG LIMITED
- Kowloon Bay Office

**1/F Pacific Trade Centre,
2 Kai Hing Road, Kowloon Bay,
Kowloon, HONG KONG**

Tel: +852 2331 0888
Fax: +852 2331 0889
www.cps.bureauveritas.com

TEST REPORT No.: (5209)180-0049

Electrostatic Discharge

Test Requirement: EN 55024
Test Method: IEC 61000-4-2
Test Level: $\pm 4\text{kV}$ for Direct & Indirect Contact Discharge
 $\pm 8\text{kV}$ for Air Discharge

Performance Criterion Requirement: B

Temperature: 23.0 °C
Humidity: 53.0 %
Atmospheric Pressure: 101.4 kPa

Test Date(s): 2009-06-30

Mode of Operation: Program running mode (Connected to PC)

Test Method:

The test was performed in accordance with IEC 61000-4-2.

Test Setup:

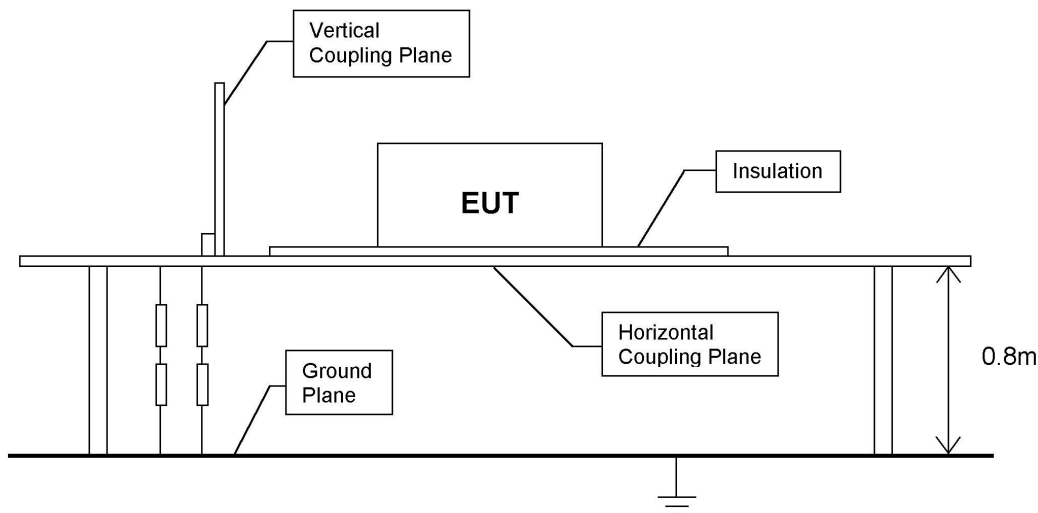

This report is intended for your exclusive use. Any copying or replication of this report to or for any other person or entity, or use of our name or trademark, is permitted only with our prior written permission. Our report is limited to the test samples identified herein. The results set forth in this report are not necessarily indicative or representative of the statistical quality or characteristics of the lot from which a test sample was taken or any similar or identical product unless specifically and expressly noted. Our report includes all of the tests requested by you and the results thereof. You shall have thirty days from receipt of this report to request additional testing of the samples or to notify us of any errors or omissions relating to our report, provided, however, such notice shall be in writing and shall specifically address the issue you wish to raise. A failure to raise such issue within the prescribed time shall constitute your unqualified acceptance of the completeness of this report, the tests conducted and the correctness of the report contents.

BUREAU VERITAS HONG KONG LIMITED
- Kowloon Bay Office

1/F Pacific Trade Centre,
2 Kai Hing Road, Kowloon Bay,
Kowloon, HONG KONG

Tel: +852 2331 0888
Fax: +852 2331 0889
www.cps.bureauveritas.com



TEST REPORT No.: (5209)180-0049

Test Levels for Electrostatic Discharge:

Level	Test Voltage Direct & Indirect Contact Discharge	Test Voltage Air Discharge
1	±2kV	±2kV
2	±4kV	±4kV
3	±6kV	±8kV
4	±8kV	±15kV

Test Result of (Program running mode, connected to PC): PASS

Please refer to the following table for individual results.

Location	Discharge Method	Test Voltage	Individual Results	
			Pass	Failed
HCP [Horizontal Coupling Plane]	Indirect Contact	±4kV	<input checked="" type="checkbox"/>	<input type="checkbox"/>
VCP [Vertical Coupling Plane]	Indirect Contact	±4kV	<input checked="" type="checkbox"/>	<input type="checkbox"/>
Enclosure	Air	±8kV	<input checked="" type="checkbox"/>	<input type="checkbox"/>
Metallic part	Direct Contact	±4kV	<input checked="" type="checkbox"/>	<input type="checkbox"/>

This report is intended for your exclusive use. Any copying or replication of this report to or for any other person or entity, or use of our name or trademark, is permitted only with our prior written permission. Our report is limited to the test samples identified herein. The results set forth in this report are not necessarily indicative or representative of the statistical quality or characteristics of the lot from which a test sample was taken or any similar or identical product unless specifically and expressly noted. Our report includes all of the tests requested by you and the results thereof. You shall have thirty days from receipt of this report to request additional testing of the samples or to notify us of any errors or omissions relating to our report, provided, however, such notice shall be in writing and shall specifically address the issue you wish to raise. A failure to raise such issue within the prescribed time shall constitute your unqualified acceptance of the completeness of this report, the tests conducted and the correctness of the report contents.

BUREAU VERITAS HONG KONG LIMITED
- Kowloon Bay Office

1/F Pacific Trade Centre,
2 Kai Hing Road, Kowloon Bay,
Kowloon, HONG KONG

Tel: +852 2331 0888
Fax: +852 2331 0889
www.cps.bureauveritas.com

TEST REPORT No.: (5209)180-0049

Electrical Fast Transients on AC Supply

Test Requirement: EN 55024
 Test Method: IEC 61000-4-4
 Test Level: $\pm 1\text{kV}$

Performance Criterion Requirement: B

Temperature: 23.0 °C
 Humidity: 53.0 %
 Atmospheric Pressure: 101.4 kPa

Test Date(s): 2009-06-29

Mode of Operation: Program running mode (Connected to PC)

Test Method:

The test was performed in accordance with IEC 61000-4-4.

Test Setup:

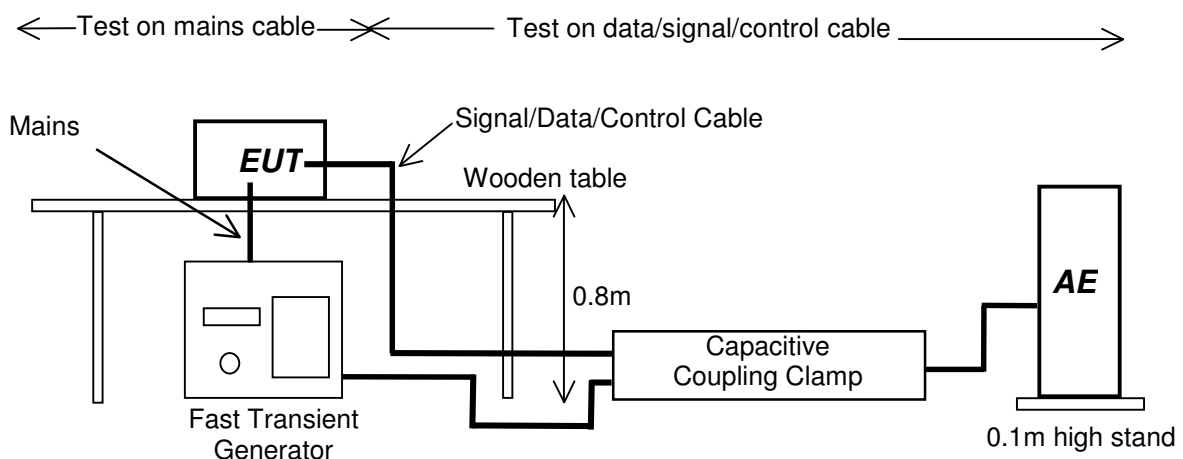

This report is intended for your exclusive use. Any copying or replication of this report to or for any other person or entity, or use of our name or trademark, is permitted only with our prior written permission. Our report is limited to the test samples identified herein. The results set forth in this report are not necessarily indicative or representative of the statistical quality or characteristics of the lot from which a test sample was taken or any similar or identical product unless specifically and expressly noted. Our report includes all of the tests requested by you and the results thereof. You shall have thirty days from receipt of this report to request additional testing of the samples or to notify us of any errors or omissions relating to our report, provided, however, such notice shall be in writing and shall specifically address the issue you wish to raise. A failure to raise such issue within the prescribed time shall constitute your unqualified acceptance of the completeness of this report, the tests conducted and the correctness of the report contents.



TEST REPORT No.: (5209)180-0049

Test Levels for Electrical Fast Transient:

Level	On power supply port, PE		On I/O (Input/Output) signal, data and control ports	
	Voltage peak [kV]	Repetition rate [kHz]	Voltage peak [kV]	Repetition rate [kHz]
1	0.5	5.0	0.25	5.0
2	1.0	5.0	0.50	5.0
3	2.0	5.0	1.00	5.0
4	4.0	5.0	2.00	5.0

Test Result of (Program running mode, connected to PC): PASS

Please refer to the following table for individual results

Conductor	Polarity & Level	Duration (s)	Individual Results	
			Pass	Failed
Live – Neutral – Earth	±1kV	120	<input checked="" type="checkbox"/>	<input type="checkbox"/>

This report is intended for your exclusive use. Any copying or replication of this report to or for any other person or entity, or use of our name or trademark, is permitted only with our prior written permission. Our report is limited to the test samples identified herein. The results set forth in this report are not necessarily indicative or representative of the statistical quality or characteristics of the lot from which a test sample was taken or any similar or identical product unless specifically and expressly noted. Our report includes all of the tests requested by you and the results thereof. You shall have thirty days from receipt of this report to request additional testing of the samples or to notify us of any errors or omissions relating to our report, provided, however, such notice shall be in writing and shall specifically address the issue you wish to raise. A failure to raise such issue within the prescribed time shall constitute your unqualified acceptance of the completeness of this report, the tests conducted and the correctness of the report contents.

BUREAU VERITAS HONG KONG LIMITED
- Kowloon Bay Office

1/F Pacific Trade Centre,
2 Kai Hing Road, Kowloon Bay,
Kowloon, HONG KONG

Tel: +852 2331 0888
Fax: +852 2331 0889
www.cps.bureauveritas.com

TEST REPORT No.: (5209)180-0049

Radiated Immunity (80MHz to 1000MHz)

Test Requirement: EN 55024
Test Method: IEC 61000-4-3
Test Level: 3V/m
Modulation: 80% 1kHz AM

Performance Criterion Requirement: A

Temperature: 22.0 °C
Humidity: 55.0 %
Atmospheric Pressure: 101.1 kPa

Test Date(s): 2009-06-27

Mode of Operation: Program running mode (Connected to PC)

Test Method:

The test was performed in accordance with IEC 61000-4-3.

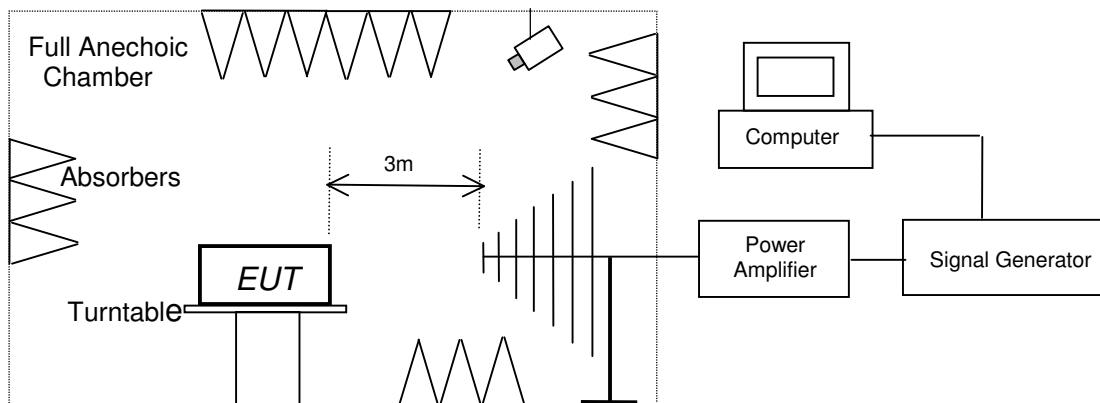

This report is intended for your exclusive use. Any copying or replication of this report to or for any other person or entity, or use of our name or trademark, is permitted only with our prior written permission. Our report is limited to the test samples identified herein. The results set forth in this report are not necessarily indicative or representative of the statistical quality or characteristics of the lot from which a test sample was taken or any similar or identical product unless specifically and expressly noted. Our report includes all of the tests requested by you and the results thereof. You shall have thirty days from receipt of this report to request additional testing of the samples or to notify us of any errors or omissions relating to our report, provided, however, such notice shall be in writing and shall specifically address the issue you wish to raise. A failure to raise such issue within the prescribed time shall constitute your unqualified acceptance of the completeness of this report, the tests conducted and the correctness of the report contents.

BUREAU VERITAS HONG KONG LIMITED
- Kowloon Bay Office

1/F Pacific Trade Centre,
2 Kai Hing Road, Kowloon Bay,
Kowloon, HONG KONG

Tel: +852 2331 0888
Fax: +852 2331 0889
www.cps.bureauveritas.com



TEST REPORT No.: (5209)180-0049

Test Result of (Program running mode, connected to PC): PASS

Please refer to the following table for individual results.

Frequency (MHz)	Face	Polarity	Level (V/m)	Dwell Time (s)	Individual Results	
					Pass	Failed
80-1000	0°	Horizontal / Vertical	3	3	<input checked="" type="checkbox"/>	<input type="checkbox"/>
80-1000	90°	Horizontal / Vertical	3	3	<input checked="" type="checkbox"/>	<input type="checkbox"/>
80-1000	180°	Horizontal / Vertical	3	3	<input checked="" type="checkbox"/>	<input type="checkbox"/>
80-1000	270°	Horizontal / Vertical	3	3	<input checked="" type="checkbox"/>	<input type="checkbox"/>

This report is intended for your exclusive use. Any copying or replication of this report to or for any other person or entity, or use of our name or trademark, is permitted only with our prior written permission. Our report is limited to the test samples identified herein. The results set forth in this report are not necessarily indicative or representative of the statistical quality or characteristics of the lot from which a test sample was taken or any similar or identical product unless specifically and expressly noted. Our report includes all of the tests requested by you and the results thereof. You shall have thirty days from receipt of this report to request additional testing of the samples or to notify us of any errors or omissions relating to our report, provided, however, such notice shall be in writing and shall specifically address the issue you wish to raise. A failure to raise such issue within the prescribed time shall constitute your unqualified acceptance of the completeness of this report, the tests conducted and the correctness of the report contents.

BUREAU VERITAS HONG KONG LIMITED
- Kowloon Bay Office

1/F Pacific Trade Centre,
2 Kai Hing Road, Kowloon Bay,
Kowloon, HONG KONG

Tel: +852 2331 0888
Fax: +852 2331 0889
www.cps.bureauveritas.com

TEST REPORT No.: (5209)180-0049

Surge Immunity on AC Supply

Test Requirement: EN 55024
 Test Method: IEC 61000-4-5
 Test Level: $\pm 1.0\text{kV}$ (between live & neutral)
 $\pm 2.0\text{kV}$ (between live & earth)
 $\pm 2.0\text{kV}$ (between neutral & earth)

Performance Criterion Requirement: B

Temperature: 23.0 °C
 Humidity: 53.0 %
 Atmospheric Pressure: 101.4 kPa

Test Date(s): 2009-06-29

Mode of Operation: Program running mode (Connected to PC)

Test Method:

The test was performed in accordance with IEC 61000-4-5.

Test Setup:

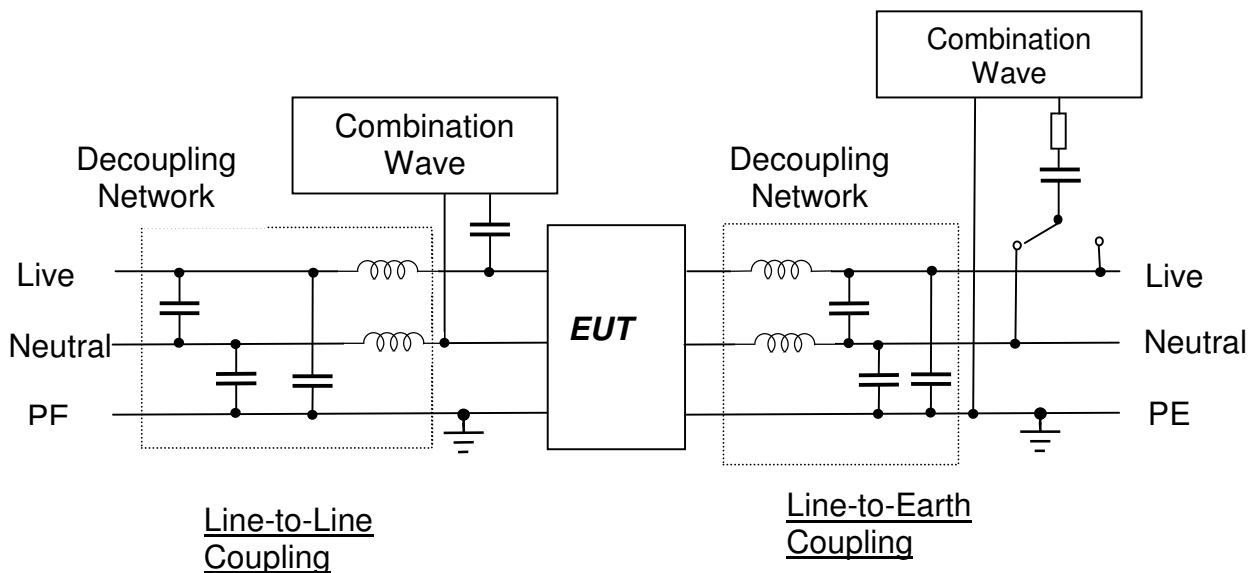

This report is intended for your exclusive use. Any copying or replication of this report to or for any other person or entity, or use of our name or trademark, is permitted only with our prior written permission. Our report is limited to the test samples identified herein. The results set forth in this report are not necessarily indicative or representative of the statistical quality or characteristics of the lot from which a test sample was taken or any similar or identical product unless specifically and expressly noted. Our report includes all of the tests requested by you and the results thereof. You shall have thirty days from receipt of this report to request additional testing of the samples or to notify us of any errors or omissions relating to our report, provided, however, such notice shall be in writing and shall specifically address the issue you wish to raise. A failure to raise such issue within the prescribed time shall constitute your unqualified acceptance of the completeness of this report, the tests conducted and the correctness of the report contents.

BUREAU VERITAS HONG KONG LIMITED
 - Kowloon Bay Office

1/F Pacific Trade Centre,
 2 Kai Hing Road, Kowloon Bay,
 Kowloon, HONG KONG

Tel: +852 2331 0888
 Fax: +852 2331 0889
 www.cps.bureauveritas.com

TEST REPORT No.: (5209)180-0049

Test Levels for Surge Immunity:

Level	Open-circuit test voltage ±10%
1	0.5 kV
2	1.0 kV
3	2.0 kV
4	4.0 kV

Test Result of (Program running mode, connected to PC): PASS

Please refer to the following table for individual results.

Conductor	Level & Polarity	No. of Surge	Phase Angle	Surge Interval	Individual Results	
					Pass	Failed
Live - Neutral	±1.0kV	5	0°	60s	<input checked="" type="checkbox"/>	<input type="checkbox"/>
			90°		<input checked="" type="checkbox"/>	<input type="checkbox"/>
			180°		<input checked="" type="checkbox"/>	<input type="checkbox"/>
			270°		<input checked="" type="checkbox"/>	<input type="checkbox"/>
Live - Earth	±2.0kV	5	0°	60s	<input checked="" type="checkbox"/>	<input type="checkbox"/>
			90°		<input checked="" type="checkbox"/>	<input type="checkbox"/>
			180°		<input checked="" type="checkbox"/>	<input type="checkbox"/>
			270°		<input checked="" type="checkbox"/>	<input type="checkbox"/>
Neutral - Earth	±2.0kV	5	0°	60s	<input checked="" type="checkbox"/>	<input type="checkbox"/>
			90°		<input checked="" type="checkbox"/>	<input type="checkbox"/>
			180°		<input checked="" type="checkbox"/>	<input type="checkbox"/>
			270°		<input checked="" type="checkbox"/>	<input type="checkbox"/>

This report is intended for your exclusive use. Any copying or replication of this report to or for any other person or entity, or use of our name or trademark, is permitted only with our prior written permission. Our report is limited to the test samples identified herein. The results set forth in this report are not necessarily indicative or representative of the statistical quality or characteristics of the lot from which a test sample was taken or any similar or identical product unless specifically and expressly noted. Our report includes all of the tests requested by you and the results thereof. You shall have thirty days from receipt of this report to request additional testing of the samples or to notify us of any errors or omissions relating to our report, provided, however, such notice shall be in writing and shall specifically address the issue you wish to raise. A failure to raise such issue within the prescribed time shall constitute your unqualified acceptance of the completeness of this report, the tests conducted and the correctness of the report contents.

TEST REPORT No.: (5209)180-0049

Continuous RF Immunity on AC Supply (150kHz to 80MHz)

Test Requirement: EN 55024
 Test Method: IEC 61000-4-6
 Test Level: 3Vrms(emf) with 80% 1kHz AM

Performance Criterion Requirement: A

Temperature: 23.0 °C
 Humidity: 55.0 %
 Atmospheric Pressure: 101.7 kPa

Test Date(s): 2009-07-01

Mode of Operation: Program running mode (Connected to PC)

Test Method:

The test was performed in accordance with IEC 61000-4-6.

Test Setup:

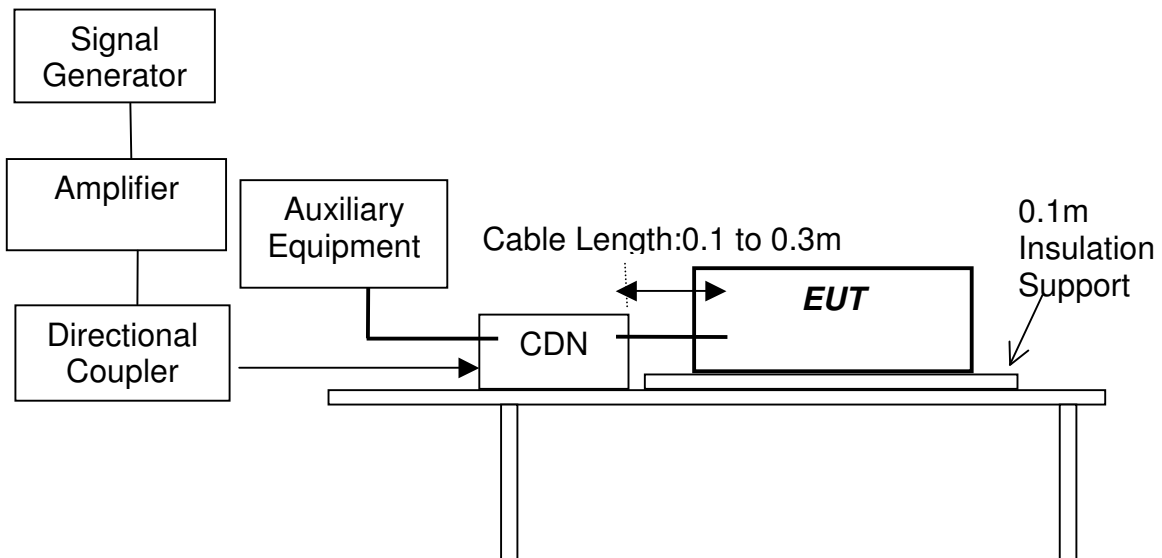

This report is intended for your exclusive use. Any copying or replication of this report to or for any other person or entity, or use of our name or trademark, is permitted only with our prior written permission. Our report is limited to the test samples identified herein. The results set forth in this report are not necessarily indicative or representative of the statistical quality or characteristics of the lot from which a test sample was taken or any similar or identical product unless specifically and expressly noted. Our report includes all of the tests requested by you and the results thereof. You shall have thirty days from receipt of this report to request additional testing of the samples or to notify us of any errors or omissions relating to our report, provided, however, such notice shall be in writing and shall specifically address the issue you wish to raise. A failure to raise such issue within the prescribed time shall constitute your unqualified acceptance of the completeness of this report, the tests conducted and the correctness of the report contents.



TEST REPORT No.: (5209)180-0049

Test Levels for Continuous RF Immunity:

Frequency range 150kHz - 80MHz		
Level	Voltage level (emf)	
	U _o [dB(μV)]	U _o [V]
1	120	1
2	130	3
3	140	10

Test Result of (Program running mode, connected to PC): PASS

Please refer to the following table for individual results.

Frequency (MHz)	Level (Vrms)	Dwell Time (s)	Sweep rate (%)	Individual Results	
				Pass	Failed
0.15 – 80	3.0	3	1	<input checked="" type="checkbox"/>	<input type="checkbox"/>

This report is intended for your exclusive use. Any copying or replication of this report to or for any other person or entity, or use of our name or trademark, is permitted only with our prior written permission. Our report is limited to the test samples identified herein. The results set forth in this report are not necessarily indicative or representative of the statistical quality or characteristics of the lot from which a test sample was taken or any similar or identical product unless specifically and expressly noted. Our report includes all of the tests requested by you and the results thereof. You shall have thirty days from receipt of this report to request additional testing of the samples or to notify us of any errors or omissions relating to our report, provided, however, such notice shall be in writing and shall specifically address the issue you wish to raise. A failure to raise such issue within the prescribed time shall constitute your unqualified acceptance of the completeness of this report, the tests conducted and the correctness of the report contents.

BUREAU VERITAS HONG KONG LIMITED
- Kowloon Bay Office

1/F Pacific Trade Centre,
2 Kai Hing Road, Kowloon Bay,
Kowloon, HONG KONG

Tel: +852 2331 0888
Fax: +852 2331 0889
www.cps.bureauveritas.com



TEST REPORT No.: (5209)180-0049

Voltage Dips, Interruptions and Variations on AC Supply

Test Requirement: EN 55024
 Test Method: IEC 61000-4-11
 Test Level: [0, 0, 70]% of U_T

Temperature: 23.0 °C
 Humidity: 53.0 %
 Atmospheric Pressure: 101.4 kPa

Test Date(s): 2009-06-29

Mode of Operation: Program running mode (Connected to PC)

Test Method:

The test was performed in accordance with IEC 61000-4-11.

Test Levels for voltage dips, short interruptions and voltage variations immunity:

Test Level (% of U_T)	Voltage dip and short interruptions (%)	Duration (period)	Performance Criterion
0	100	0.5	B
0	100	250	C
70	30	25	C

Test Result of (Program running mode, connected to PC): PASS

Please refer to the following table for individual results.

Phase	Test Level (% of U_T)	Duration (period)	Individual Results	
			Pass	Failed
0° followed by 180°	0	0.5	<input checked="" type="checkbox"/>	<input type="checkbox"/>
0° followed by 180°	0	250	<input checked="" type="checkbox"/>	<input type="checkbox"/>
0° followed by 180°	70	25	<input checked="" type="checkbox"/>	<input type="checkbox"/>

******* End of Test Report *******

This report is intended for your exclusive use. Any copying or replication of this report to or for any other person or entity, or use of our name or trademark, is permitted only with our prior written permission. Our report is limited to the test samples identified herein. The results set forth in this report are not necessarily indicative or representative of the statistical quality or characteristics of the lot from which a test sample was taken or any similar or identical product unless specifically and expressly noted. Our report includes all of the tests requested by you and the results thereof. You shall have thirty days from receipt of this report to request additional testing of the samples or to notify us of any errors or omissions relating to our report, provided, however, such notice shall be in writing and shall specifically address the issue you wish to raise. A failure to raise such issue within the prescribed time shall constitute your unqualified acceptance of the completeness of this report, the tests conducted and the correctness of the report contents.

BUREAU VERITAS HONG KONG LIMITED
 - Kowloon Bay Office

1/F Pacific Trade Centre,
 2 Kai Hing Road, Kowloon Bay,
 Kowloon, HONG KONG

Tel: +852 2331 0888
 Fax: +852 2331 0889
 www.cps.bureauveritas.com